

SHIELDED SMD CHIP POWER INDUCTOR



ASPI-1367



RoHS
Compliant

14.0 x 12.9 x 6.7mm

FEATURES:

- 100%lead (Pb) free.
- Lowest DCR/uH, in this package size.
- Frequency range up to 5.0MHZ.
- Handles high transient current spikes without saturation
- Ultra low buzz noise, due to composite construction.

APPLICATIONS:

- PDA/Notebook/Desktop/Server applications.
- Low profile, high current power supplies.
- Battery powered devices.
- DC/DC converter for Field Programmable Gate Array(FPGA)

ELECTRICAL SPECIFICATIONS:

ABRACON P/N:	ASPI-1367
Operating Temperature:	-40°C to +125°C
Storage Temperature:	Less than +40°C, 70% RH.

Part Number ASPI-1367-	L (μ H)	Tolerance (M, N)	$R_{DC}(\Omega)$		I_{sat} (A)	I_{rms} (A)
			Typ	Max		
R10	0.1	N	0.25	0.5	80.0	60.0
R33	0.33	M	0.6	0.8	65.0	46.0
2R2	2.2	M	3.8	4.2	33.0	20.0
3R3	3.3	M	5.5	6.8	29.0	15.0
4R7	4.7	M	9.5	11.2	25.0	13.5
5R6	5.6	M	10.5	11.5	24.0	12.0
6R8	6.8	M	13.5	14.9	16.5	11.5
8R2	8.2	M	15.2	16.6	16.0	10.5
100	10	M	17.0	18.5	15.5	10.0

Test Conditions

1. Inductance tested at 200kHz, 0.25V, 0A; Tolerance M= \pm 20%, N= \pm 30%
2. All test data is in reference to 25°C ambient.
3. Isat will cause the inductance value to drop approximately 30%
4. Irms will cause an approximate ΔT of 40°C
5. The part temperature (ambient + temp. rise) should not exceed 125°C under worst case operating conditions. Circuit design, component placement, PWB trace size and thickness, airflow and other cooling provisions all affect the part temperature. Part temperature should be verified in the end application.
6. Please contact Abracon for the availability of other inductance values.

OPTIONS AND PART IDENTIFICATION

ASPI-1367- -

Inductance Code
Please refer to the
Electrical Spec Table

Tolerance
M: \pm 20% *
N: \pm 30% *

Packaging
T: Tape and Reel (250pcs / reel)

*N for 0.1 μ H

*M for 0.33~10 μ H



SHIELDED SMD CHIP POWER INDUCTOR



14.0 x 12.9 x 6.7mm

ASPI-1367



RoHS
Compliant

INDUCTANCE AND TEMPERATURE CURVE

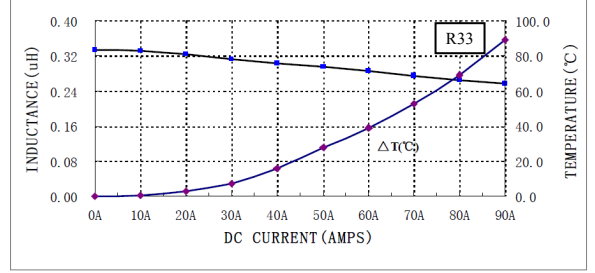
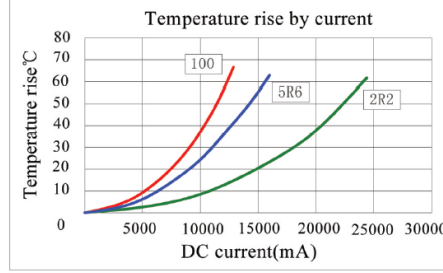
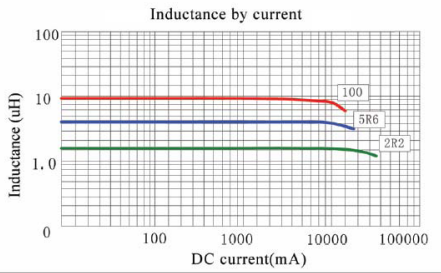

OUTLINE DIMENSIONS:

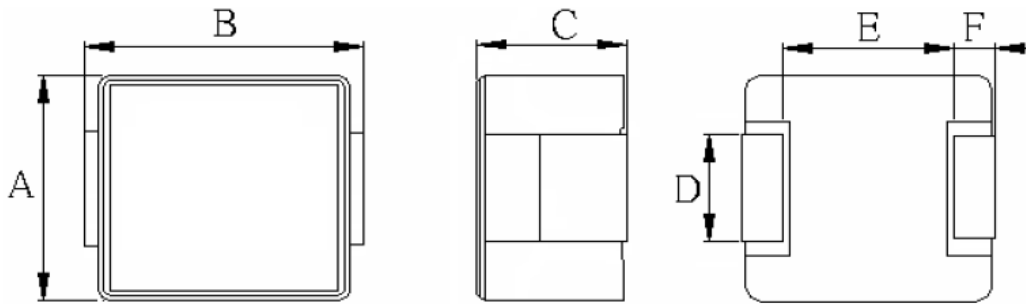

A	B	C	D	E	F
12.9 max.	14.0 max.	6.7 max.	4.0±0.5 for L≤1.5uH 3.0±0.5 for L=2.2uH 4.7±0.3 for L>2.2uH	8.4 ref.	2.0±0.5

Recommended Land Pattern

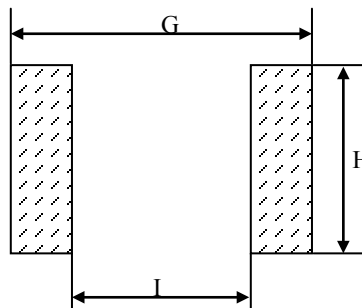

G	H	I
14.5	5.0	8.0

Dimension: mm

ABRACON IS
ISO 9001:2008
CERTIFIED



ABRACON
CORPORATION

Visit www.abracon.com for Terms & Conditions of Sale
30332 Esperanza, Rancho Santa Margarita, California 92688
tel 949-546-8000 | fax 949-546-8001 | www.abracon.com

Revised: 04.04.12

SHIELDED SMD CHIP POWER INDUCTOR



14.0 x 12.9 x 6.7mm

ASPI-1367



RoHS
Compliant

REFLOW PROFILE:

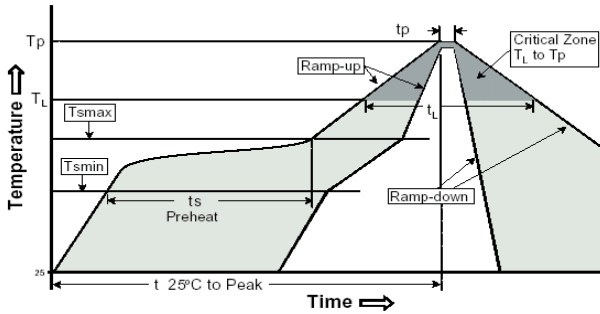

Profile Feature	Assembly
Average Ramp-Up Rate (Ts _{max} to Tp)	3°C/second max.
Preheat -Temperature Min (Ts _{min}) -Temperature Max (Ts _{max}) -Time (ts _{min} to ts _{max})	150°C 200°C 60-180 seconds
Time maintained above: -Temperature (T _L) -Time (t _r)	217°C 60-150 seconds
Peak/Classification Temperature (Tp)	245 +0°C
Time within 5°C of actual Peak Temperature (tp)	20-40 seconds
Ramp-Down Rate	6°C/seconds max
Time 25°C to Peak Temperature	8 minutes max.

Storage Conditions and Handling

- (1) Temperature and humidity conditions : less than 40°C and 70% RH.
- (2) Products should be used within 6 months.
- (3) The packaging material should be kept where no chlorine or sulfur exists in the air.
- (4) Do not touch the electrodes (soldering terminals) with fingers as this may lead to deterioration of solder ability
- (5) The use of tweezers or vacuum pick-ups is strongly recommended for individual components.
- (6) Bulk handling should ensure that abrasion and mechanical shock are minimized.

TAPE & REEL:

T= tape and reel (250pcs/reel)

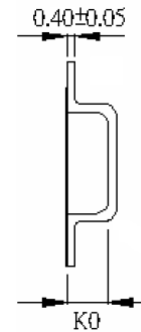
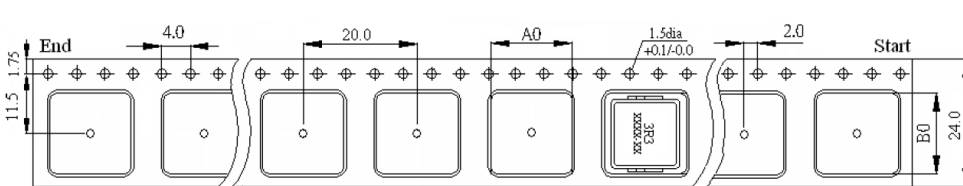

A ₀	B ₀	K ₀
13.2	13.9	7.0

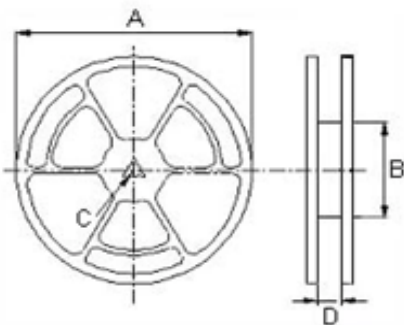

A	B	C	D
330	100	13.5	24

Dimension: mm

ATTENTION: Abracon Corporation's products are COTS – Commercial-Off-The-Shelf products; suitable for Commercial, Industrial and, where designated, Automotive Applications. Abracon's products are not specifically designed for Military, Aviation, Aerospace, Life-dependant Medical applications or any application requiring high reliability where component failure could result in loss of life and/or property. For applications requiring high reliability and/or presenting an extreme operating environment, written consent and authorization from Abracon Corporation is required. Please contact Abracon Corporation for more information.

ABRACON IS
ISO 9001:2008
CERTIFIED



ABRACON
CORPORATION

Visit www.abracon.com for Terms & Conditions of Sale **Revised: 04.04.12**
30332 Esperanza, Rancho Santa Margarita, California 92688
tel 949-546-8000 | fax 949-546-8001 | www.abracon.com